

# PRESSURE- AND TEMPERATURE-COMPENSATED FLOW CONTROL VALVE (HF3H) SIZE 025 / 03 / 06

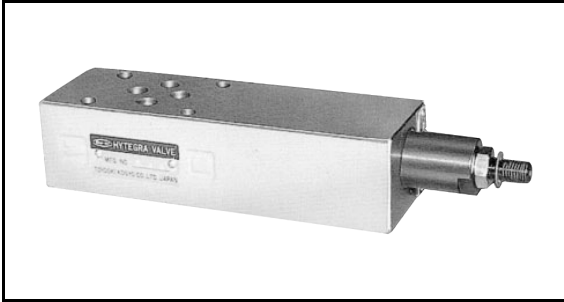

## SPECIFICATIONS

Controlled Port	Type	Model	Max. Operating Pressure (MPa)	Flow Adjustment Range (L/min)	Cracking Pressure of Check Valve (MPa)	Symbol	
P	—	HF3H-P-K24-025B	25	0.3 to 24	0.04		
		HF3H-P-K6-025B		0.3 to 6			
		HF3H-P-K56-03	21	0.5 to 56			
		HF3H-P-K106-06		2.0 to 106			
A	Meter-out	HF3H-A-K24K-025B	25	0.3 to 24		0.04	
		HF3H-A-K6K-025B		0.3 to 6			
		HF3H-A-K56K-03	21	0.5 to 56			
		HF3H-A-K106K-06		2.0 to 106			
	Meter-in	HF3H-AY-K24K-025B	25	0.3 to 24	0.04		
		HF3H-AY-K6K-025B		0.3 to 6			
		HF3H-AY-K56K-03	21	0.5 to 56			
		HF3H-AY-K106K-06		2.0 to 106			
B	Meter-out	HF3H-B-K24K-025B	25	0.3 to 24		0.04	
		HF3H-B-K6K-025B		0.3 to 6			
		HF3H-B-K56K-03	21	0.5 to 56			
		HF3H-B-K106K-06		2.0 to 106			
	Meter-in	HF3H-BY-K24K-025B	25	0.3 to 24	0.04		
		HF3H-BY-K6K-025B		0.3 to 6			
		HF3H-BY-K56K-03	21	0.5 to 56			
		HF3H-BY-K106K-06		2.0 to 106			
A / B	Meter-out	HF3H-W-K24K-025B	25	0.3 to 24		0.04	
		HF3H-W-K6K-025B		0.3 to 6			
	Meter-in	HF3H-WY-K24K-025B		0.3 to 24			
		HF3H-WY-K6K-025B		0.3 to 6			

# EXTERNAL DIMENSIONS

- HF3H-P-K24-025B
- HF3H-P-K6-025B

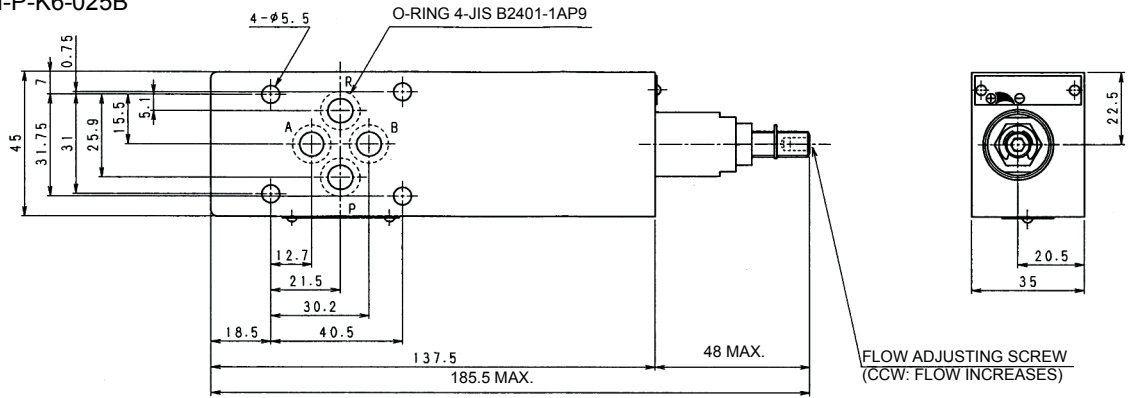

MASS: 1.5 kg

- HF3H-A(Y)-K24K-025B
- HF3H-A(Y)-K6K-025B

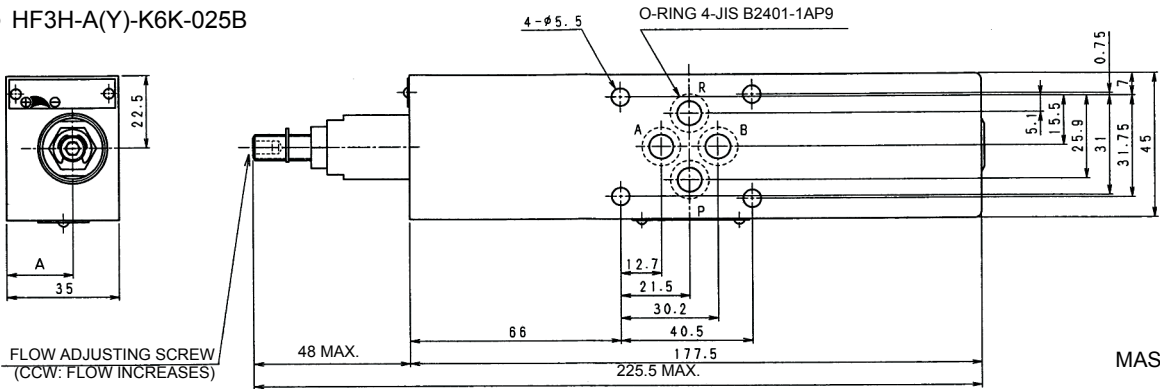

MASS: 1.9 kg

## ● Dimension Table

Unit: mm

Model	Dimension A
HF3H-A-K <sub>6</sub> <sup>24</sup> K-025B	20.5
HF3H-AY-K <sub>6</sub> <sup>24</sup> K-025B	15
HF3H-B-K <sub>6</sub> <sup>24</sup> K-025B	20.5
HF3H-BY-K <sub>6</sub> <sup>24</sup> K-025B	15

- HF3H-B(Y)-K24K-025B
- HF3H-B(Y)-K6K-025B

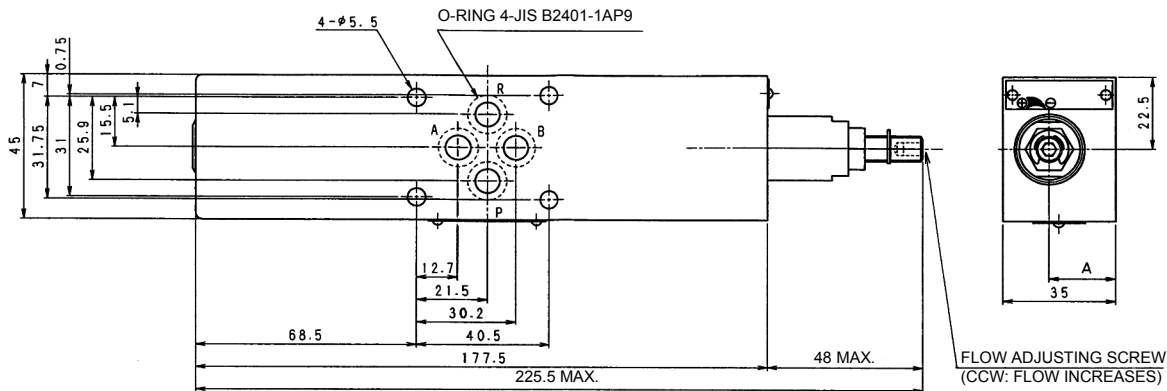

MASS: 1.9 kg

**EXTERNAL DIMENSIONS**

- HF3H-W(Y)-K24(K)-025B
- HF3H-W(Y)-K6(K)-025B

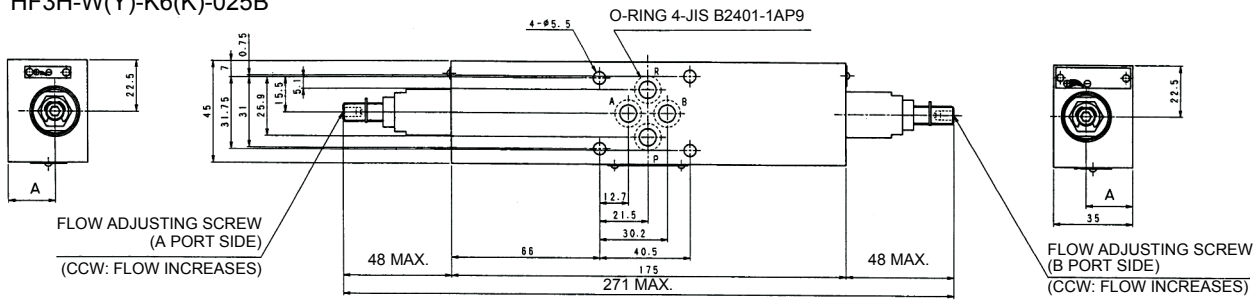

MASS: 2 kg

● Dimension Table Unit: mm

Model	Dimension A
HF3H-W-K <sub>24</sub> <sup>6</sup> (K)-025B	20.5
HF3H-WY-K <sub>24</sub> <sup>6</sup> (K)-025B	15

- HF3H-P-K56-03
- HF3H-B(Y)-K56(K)-03

- HF3H-A(Y)-K56(K)-03

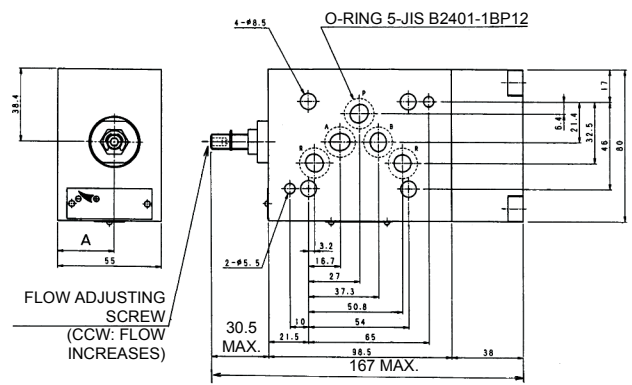
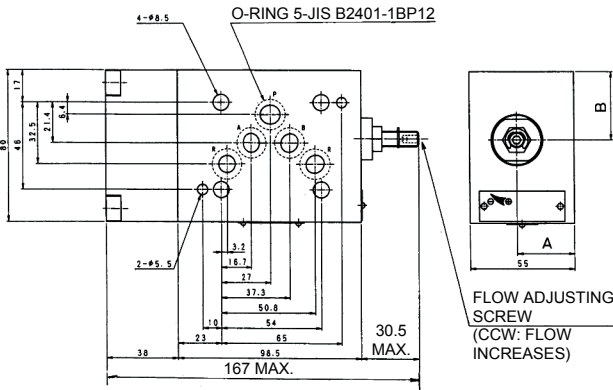

MASS: 3.2 kg

● Dimension Table Unit: mm

Model	Dimension A	Dimension B
HF3H-P-K56-03	30	36
HF3H-B-K56(K)-03	30	38.4
HF3H-BY-K56(K)-03	25	38.4

● Dimension Table Unit: mm

Model	Dimension A
HF3H-A-K56(K)-03	30
HF3H-AY-K56(K)-03	25

- HF3H-\*(Y)-K106(K)-06

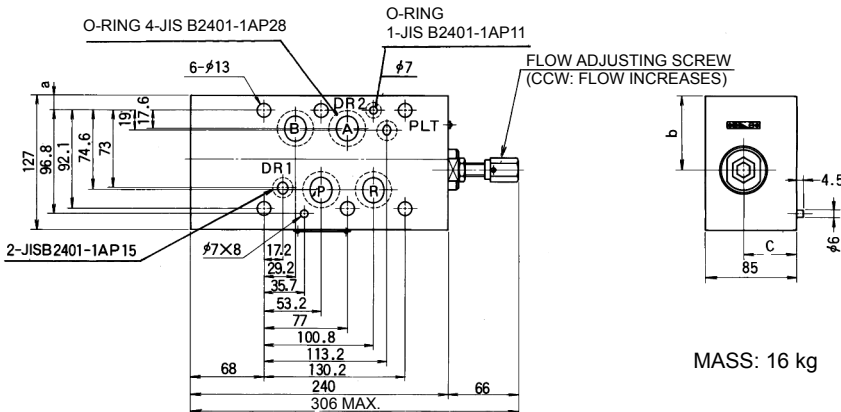

MASS: 16 kg

● Dimension Table Unit: mm

Model	a	b	c
HF3H-A-K106K-06	21	57	51
HF3H-AY-K106K-06	21	57	34
HF3H-B-K106K-06	21	57	51
HF3H-BY-K106K-06	21	57	34
HF3H-P-K106-06	14	70	51